







# Supervision Genogram: SYMBOLS

TABLE 1. Supervision Genogram Symbols

Demographic information of supervisor	
Gender:	Female  Male 
Nature of Supervisory alliance	
Normal	
Close	
Conflictual	
Distant/poor	
Terminated prematurely	
Professional context (where supervision occurred)	
ACAD	Academic department
CMHC	Community mental health center or agency
HOSP	Hospital/VA hospital
UNIV	University counseling center
PRIV	Private practice
UTC	University counseling center
RES	Residential treatment facility
COR	Correctional facility
MIL	Military medical center
MED	Medical center/clinic
SCHL	School district/system
Modes of supervision utilized	
IND	Individual supervision
GRP	Group supervision
CO-TX	Co-therapy
A/V	Review of audio/video taped tx sessions
LIVE	Live supervision or shadowing
PRES	Case presentations
SUP	Supervision of supervision

## Supervision Genogram: EXAMPLE

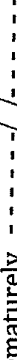
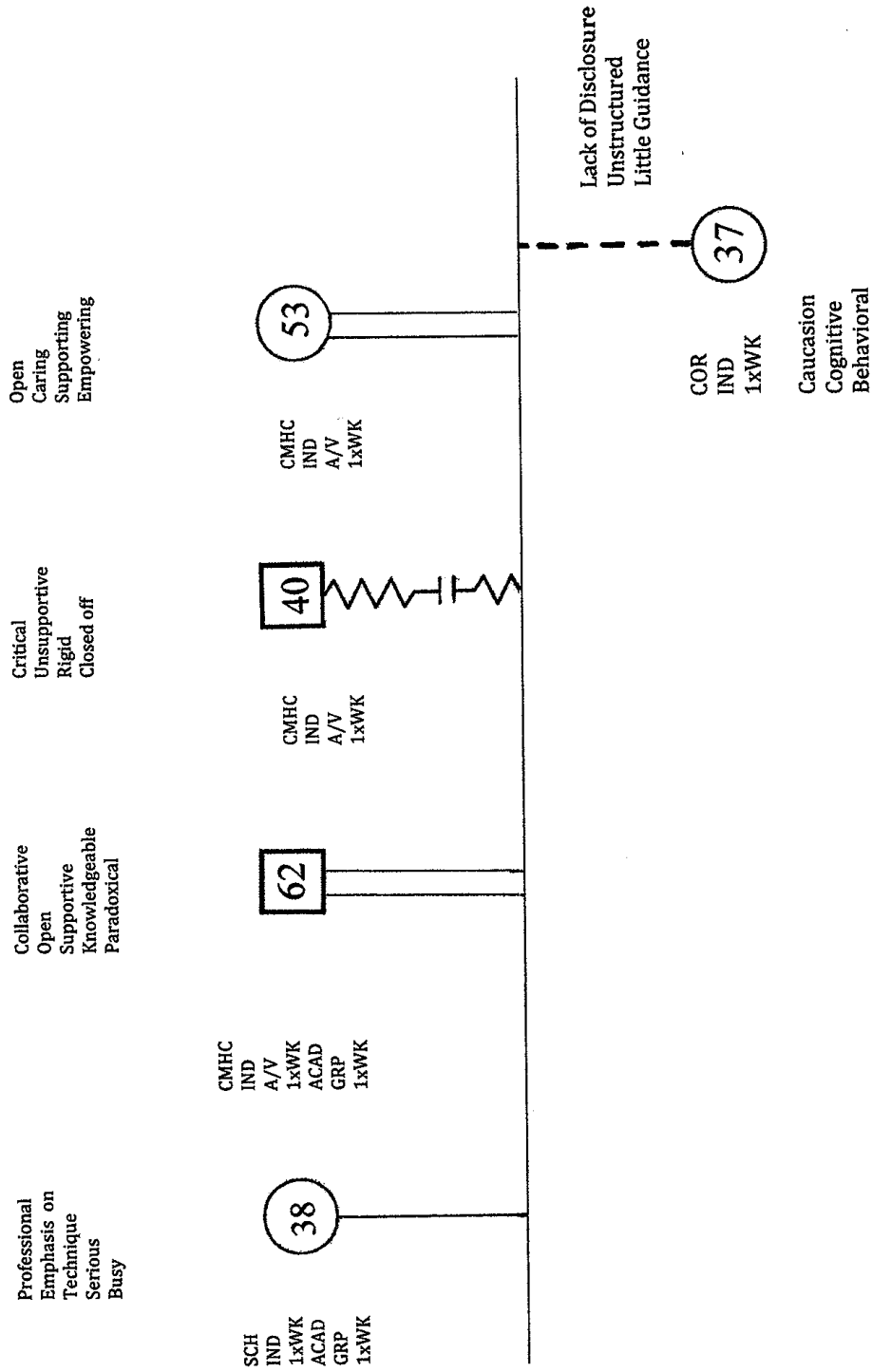

FIGURE 1. Supervision genogram